

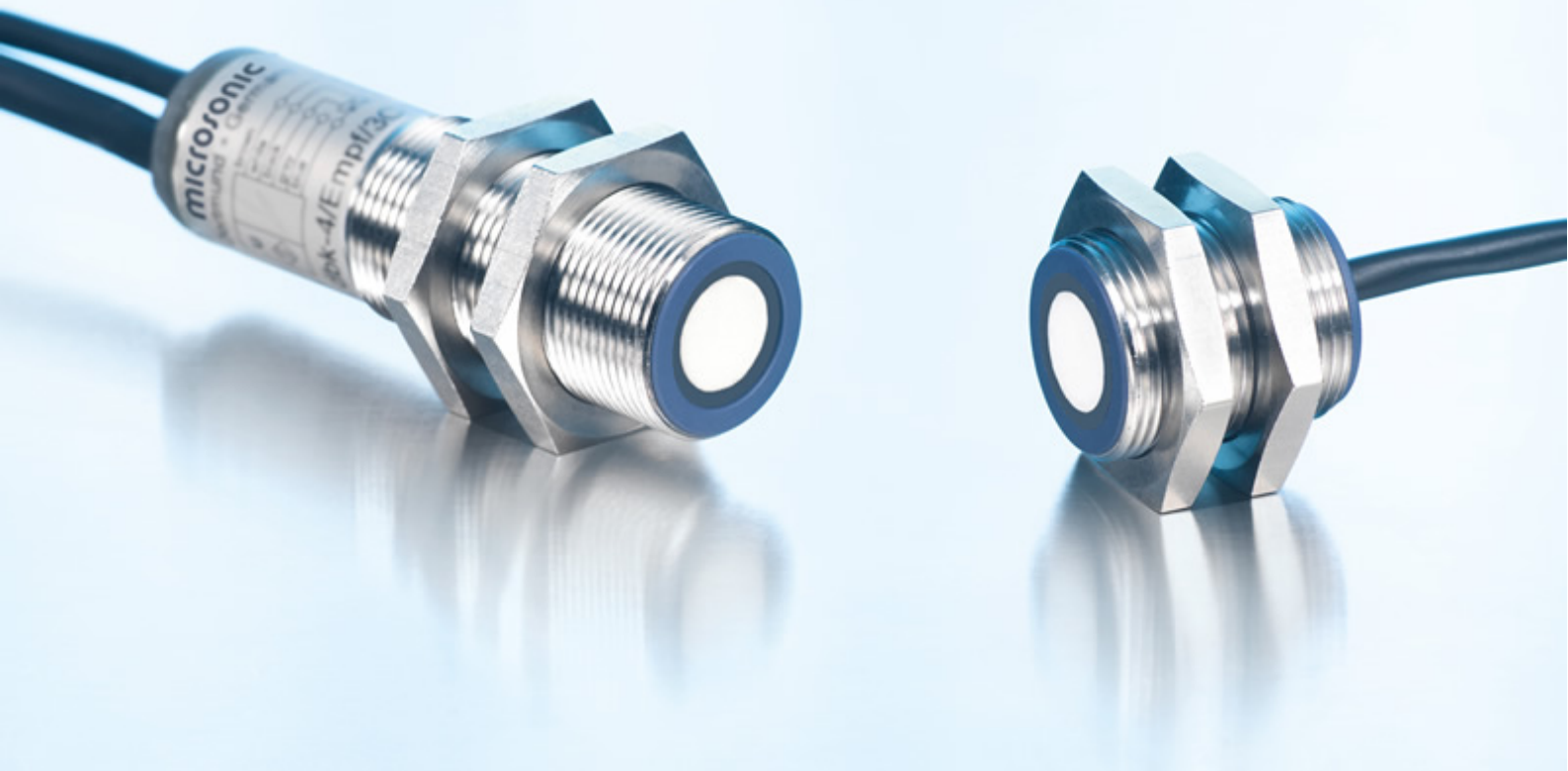

Extract from our online catalogue:

dbk+4/M12/3CDD/M18 E+S

Current to: 2018-08-27



The new ultrasonic double-sheet control dbk+4 combines multiple variants of its predecessor into a single unit, opening up entirely new possibilities for use.

## HIGHLIGHTS

- › 3 control inputs › for trigger, Teach-in and external sensitivity settings for the material
- › Teach-in option › e.g. for probing wafers stuck together by a water film
- › Variant with 90° angled head › for individual installation situations
- › Variant with external M18 receiving transducer
- › Variants with very compact transmitters and receivers in the M12 threaded sleeve

## BASICS

- › Reliable detection of single and double sheets
- › No Teach-in needed (plug and play)
- › Double sheet and missing sheet output
- › Working distance between the transmitter and the receiver selectable from 20 to 60 mm
- › Trigger option › for applications in warehouse flow
- › LinkControl › for configuration of sensors from a PC

# Description

## The task

of double-sheet control is to identify two or more pieces or sheets inadvertently adhering together.

## The functional principle

A high-frequency ultrasonic transmitter beams against the sheet from the underside. The beamed signal induces the material to vibrate. The effect of these vibrations is a very small sonic wave on the other side of the sheet being spread. This wave is evaluated by the ultrasonic receiver on the opposite side. The signal from the stacked sheet ("double sheet") is so weak that it hardly gets to the receiver. The dbk+4 detects missing, single and double sheet.

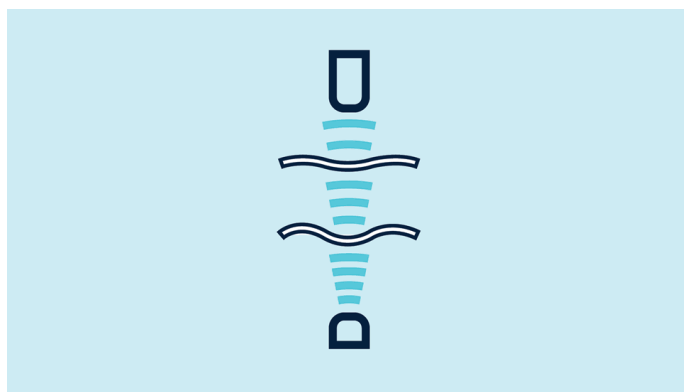

*Functional principle*

## The working ranges

The new dbk+4 has 3 control inputs by means of which 3 working range can be preselected. The standard working ranges covers the sheet material weight range from 20 g/m<sup>2</sup> to 1,200 g/m<sup>2</sup>. Extremely thin materials such as Bible printing paper with a weight per unit area of less than 20 g/m<sup>2</sup> are scanned with the use of the "Thin" setting.

The "Thick" setting is available for paperboard containers and fine-corrugated card. Changes between the working ranges can be undertaken under on-going operations. A Teach-in for the material to be scanned is not necessary.

If the 3 control inputs stay unconnected, then the dbk+4 operates in the standard working range. As such, a very broad material spectrum can be scanned.

## Teach-in

The Teach-in function is additionally available for materials which cannot be scanned with one of the three working ranges. A material Teach-in is done by inserting a single sheet into the double-sheet control. The C3 control input is then placed to logic 1 level for at least 3 seconds. Materials with non-homogeneous elements must be moved during the Teach-in phase so that the dbk+4 detect them. Success with a Teach-in operation is shown by a green LED. The material can now be scanned. The Teach-in makes it possible to scan material from thin Washi to wafers glued with a water film.

## Range of uses of dbk+4:

- › Sheet-printing machines

- › Assembly machines
- › Folding machines
- › Paper-processing machines
- › Manufacturing of solar cells and silicon wafers
- › Labelling
- › PCB manufacturing

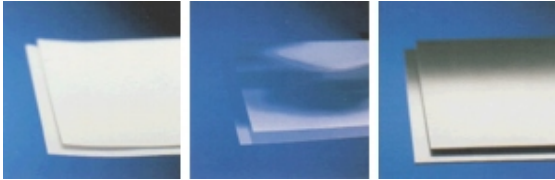

*Paper, Film, Sheet material*

### The mounting

The recommended spacing between transmitter and receiver is 40 mm (or 20 mm with dbk+4/M12/CD/M18 ER+S). If needed, this spacing can be adapted to the local conditions in the 20 to 60 mm range. For the matter of commissioning, this can be done by means of a simple Teach-in or with the LinkControl parameterisation software.



*Double-sheet control*

### Material-conditioned fitting position

With papers and thin films, the double-sheet control is effected perpendicularly to the material; flapping does not impair the function. In the case of fine-corrugated card, thin sheet metal, wafers or thicker plastic films (e. g. credit cards), the dbk+4 should to be mounted at a specific angle of inclination  $\alpha$  to the material running through.

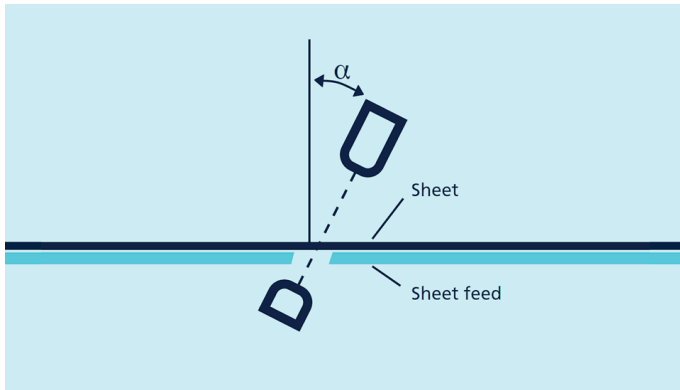

Fine-corrugated card can be optimally dimensioned at an inclination of  $\alpha \geq 35^\circ$ , thin sheet metal or thicker plastic films at  $27^\circ$  and wafers at an angle of  $11^\circ$

### The free-run mode

The dbk+4 operates as standard in the free-run mode. This means that the dbk+4 cyclically carries out measurements at a high measuring rate. Under ongoing operations, the working range can be changed and a teach-in carried out by means of the C1 to C3 control inputs.

	C1	C2	C3
Standard	0	0	0
Thick	0	1	0
Thin	1	0	0
Teach-in mode	1	1	0
Teach-in	1	1	1

Free-run mode – selection of the working range

### The trigger mode

Should, on the other hand, measurements be undertaken in applications with continuous feed, then an external trigger signal can trigger a measurement. This function is parameterised with the aid of the [LinkControl software](#). A choice can be made between edge trigger and level trigger. The C2 control input then assumes the function of the trigger input (tr).

	C1	C2	C3
Standard	0	tr	0
Thin	0	tr	1

	C1	C2	C3
Teach-in mode	1	tr	0
Teach-in	1	tr	1

*Trigger mode – selection of the working range*

Under ongoing operations, the working range can be changed by means of the C3 control input.

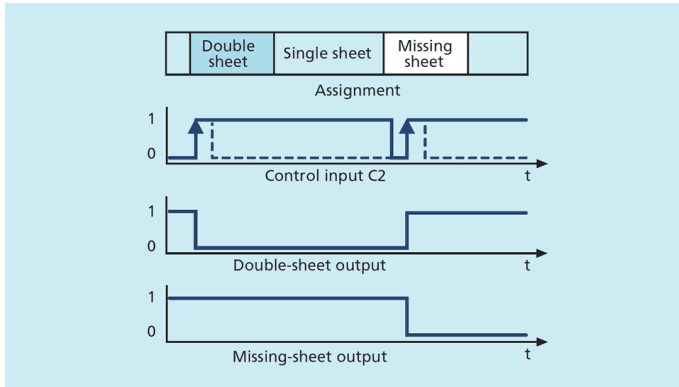

*Trigger mode – edge-controlled*

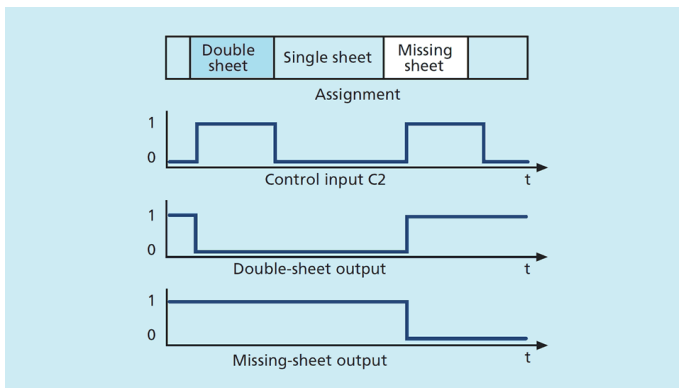

*Trigger mode – level-controlled*

### Support through LinkControl

dbk+4 can be comprehensively parameterised with the aid of the [LinkControl software](#) . To this end, the dbk+4 is connected to the LCA-2 [LinkControl adapter](#) . Using the [LinkControl software](#) , a USB cable connects the LCA-2 to the PC.

**The following parameters can be individually adapted:**

- › Spacing between transmitter and receiver
- › Double sheet - NOC/NCC
- › Single sheet or missing sheet NOC/NCC
- › Trigger mode on/off

- › Edge-controlled trigger: falling/ rising edge
- › Level-controlled trigger: high/low active
- › Switch-on delay for detecting double sheet
- › Switch-off delay for detecting double sheet
- › Threshold values for the working ranges



## Four housing variants

Four housing variants cover all imaginable fitting positions.

### a) Standard: dbk+4/3CDD/M18 E+S

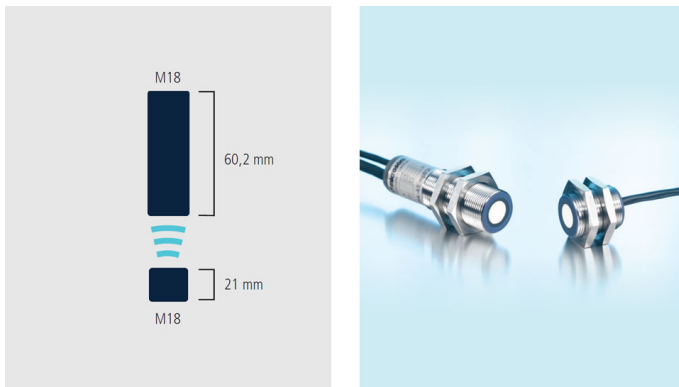

The standard: receiver and all the evaluation electronics are housed in an M18 threaded sleeve, which is only 60.2 mm long. The transmitter is housed in an M18x21 mm threaded sleeve and a 2-pin plug connects it to the receiver.

### b) Receiver with 90° angular head: dbk+4/WK/3CDD/M18 E+S

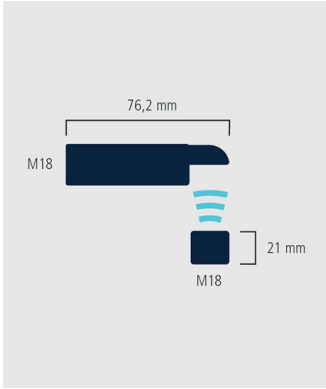

As with the standard, but here the receiver is arranged at right angles to the M18 threaded sleeve.

**dbk+4/M18/3CDD/M18 E+S**

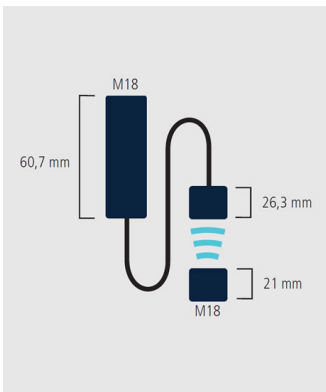

In the case of cramped fitting positions, 2 variants are available. They feature transmitter and receiver outsourced in either short M18 or M12 threaded sleeves and the receivers connected with double shielding cables to the evaluation electronics.

**dbk+4/M12/3CDD/M18 E+S**

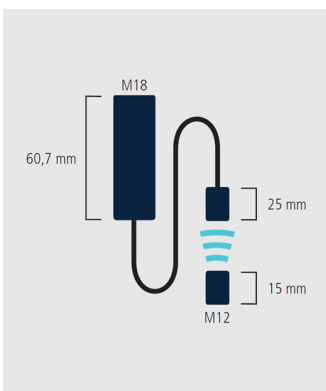

The M12-heads variant has an optimum spacing of 20 mm between transmitter and receiver.



# dbk+4/M12/3CDD/M18 E+S

## scale drawing

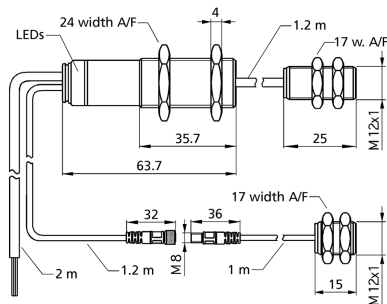

## detection zone



2 x pnp

working range	papers with weights of 20 - 600 g/m <sup>2</sup> , Washi, metal-laminated sheets and films up to 0.2 mm thick, self-adhesive films
design	cylindrical M12 with a swapped-out ultrasonic transducer
operating mode	double sheet control
particularities	Abstand zwischen Sender und Empfänger wählbar ausgelagerter Ultraschallwandler M12 Kabelanschluss

## ultrasonic-specific

means of measurement	pulse operation with amplitude evaluation
transducer frequency	500 kHz
blind zone	5 mm in front of transmitter and receiver

## electrical data

operating voltage U <sub>b</sub>	20 - 30 V d.c., reverse polarity protection
voltage ripple	± 10 %
no-load current consumption	≤ 50 mA
type of connection	2 m PUR cable, 7 x 0.25 mm <sup>2</sup>
transmitter cable	am Empfänger: 1,2 m PUR-Kabel, am Sender: 1 m PUR-Kabel, mit M8 Rundsteckverbinder; zum ausgelagerten Empfangswandler: 1,2 m PVC-Kabel

# dbk+4/M12/3CDD/M18 E+S

## outputs

output 1	double sheet output pnp: $I_{\max} = 200 \text{ mA}$ ( $U_B - 2\text{V}$ ) NOC/NCC adjustable, short-circuit-proof
output 2	missing sheet output pnp: $I_{\max} = 200 \text{ mA}$ ( $U_B - 2\text{V}$ ) NOC/NCC adjustable, short-circuit-proof
response time	< 500 $\mu\text{s}$ in trigger mode, 2.5 ms in free-run mode
delay prior to availability	< 300 ms

## inputs

description	< $-U_B + 18 \text{ V}$ : logic 1; > $-U_B + 13 \text{ V}$ or control input open: logic 0
input 1	control input
input 2	control input
input 3	control input

## housing

transmitter/receiver spacing	20 - 40 mm; optimal: 20 mm $\pm$ 2 mm
permissible angular deviation	$\pm 45^\circ$ from the perpendicular to the sheet
material	brass sleeve, nickel-plated, plastic parts, PBT, PA
ultrasonic transducer	polyurethane foam, epoxy resin with glass contents
max. tightening torque of nuts	M18: 15 Nm, M12: 3 Nm
class of protection to EN 60529	IP 65
operating temperature	+5°C to +60°C
storage temperature	-40°C to +85°C
weight	160 g
further versions	single transmitter/receiver
further versions	<a href="#">dbk+4/Sender/ M12/K1</a> <a href="#">dbk+4/Empf/M12/3CDD/ M18</a>

## technical features/characteristics

controls	control input
scope for settings	working range selection via control inputs Teach-in via control inputs LCA-2 with LinkControl
indicators	1 x Duo-LED; green: working / red: double sheet / flashing red: missing sheet
particularities	Abstand zwischen Sender und Empfänger wählbar ausgelagerter Ultraschallwandler M12 Kabelanschluss

# dbk+4/M12/3CDD/M18 E+S

[documentation \(download\)](#)

## pin assignment

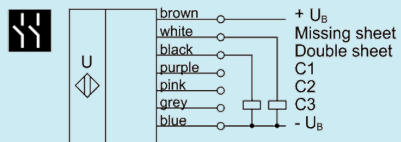

order no.

**dbk+4/M12/3CDD/M18 E+S**